

# VFR Series

The vapor tight fixture is a cost effective and energy efficient alternative to traditional fluorescent tubes or strip light fixtures. Featuring a full-length, casketed polycarbonate lens and single piece non-corrosive polycarbonate body, this vapor tight led is protected with IP65 rating, sealed and casketed against dust, dirt, and humidity, making it ideal for both indoor and outdoor harsh environments applications, including utility lighting, parking garages, freezers and cold storage facilities, food processing, car washes, stairwell lighting and low bay lighting. Additionally, ceiling or surface mounted, this led tri proof light has an initial lumen range of 105-150LPW, and features 0-10V dimming standards. As well, this model comes with a motion sensor for maximum energy savings as well as 90 mins emergency battery backup options.



## FEATURES

- UL/cUL listed for wet locations, IP65 rated
- DLC 4.4 Premium certified
- 105-130 lumens per watt
- 100-277VAC universal voltage
- 0-10V dimming optional
- Microwave Motion Sensor for Bi-Level control
- 90 mins Emergency Battery Backup

## DIMENSION:(mm/in)

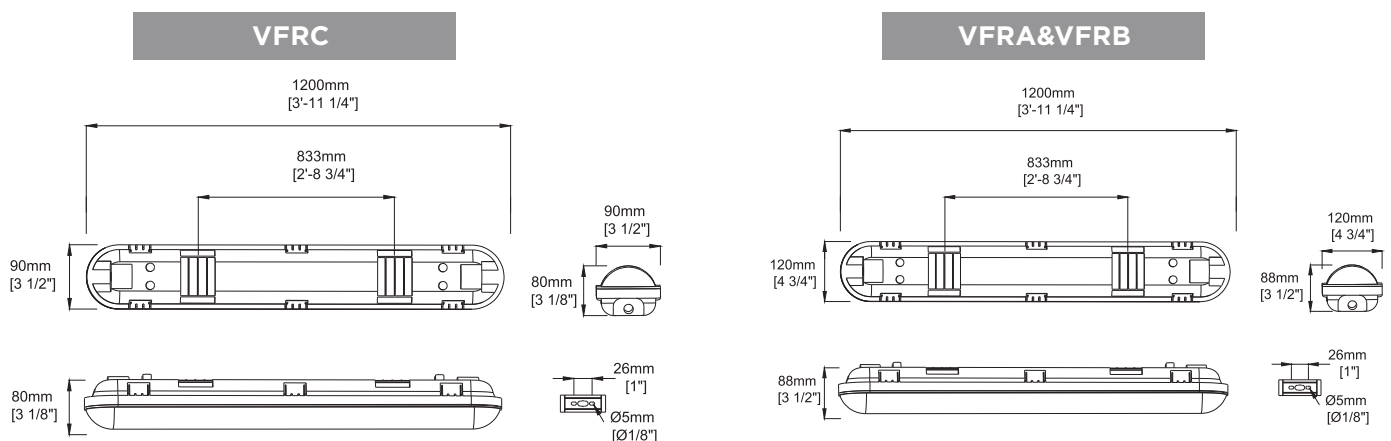

## VFR Series

### APPLICATIONS

- Wet areas
- Outside walkways
- Warehouses
- Storage areas
- Industrial units
- Farm buildings (Non-corrosive atmosphere)
- Garages
- Workshops
- Car parks
- Changing rooms
- Resistant to impact and many chemical agents, but for suitability in specific environments please take specialist advice

### CONSTRUCTION

- Grey coloured polycarbonate
- Polycarbonate diffuser integrated with powder coated lighting tray
- Stainless steel clips
- Reinforced drill points in base for direct surface fixing, or conduit suspension.
- Stainless steel surface mounting clips
- Can also be suspended from wire/chain using clips provided



Supermarket



Farm buildings



Parking lot lighting



Warehouses

### PRODUCT DETAILS



The mounting brackets keep adjustable space for easy correction.



The light transmittance of PC cover is up to 92%. The integrated design of Lens Cover and LED Plate is more convenient to install and use.



The fixed clips are elegant, secure and easy to use.

## VFR Series

### TECHNICAL SPECIFICATION

- Input Voltage : 100-277VAC
- Driver Type : UL Driver
- Luminous Efficacy : up to 130lm/w
- Colour Rendering Index : > 80Ra
- LED Type : LM80 SMD2835
- Operating : Temperature:-40°C up to 50°C (-40°F up to 122°F)
- Color Temperature : 3000K/4000K/5000K/
- Material : Polycarbonate Body & Diffuser
- Ingress Protection : IP65
- Impact Rating : IK08
- Rated Life : 50,000 hours
- Warranty : 5 years

Family Model and Variation:

**VFRB4F-XXXX[P]**-[Blank,SR,EM,RM] **VFRB4F** = Family Series;

"XXX" denotes CCT, could be 40K: 4000K, 50K: 5000K;

F = Frosted cover, C= Clear cover;

[P] denotes capability of dimming, P = 0-10 V dimming,

[Blank,SR,EM,RM] denotes product features, could be Blank,

SR: Sensor, EM: Emergency supply, RM: Sensor + Emergency supply.

USL, CNL - Light-emitting-diode surface-mounted Luminaires,

Models **VFRA4F-XXXXP-XX**, **VFRB4F-XXXXP-XX**, **VFRC4F-XXXXP-XX**,

Where the first "XXX" indicate color temperature, can be any two digit plus K. The second "X" indicate diffuser type, can be F or C, F means frosted, C means clear. "P" indicate 0-10 V dimmable, The third "XX" can be SR, EM, RM, SR means with Lighting Control, EM means with Emergency power, RM means with Lighting Control and Emergency power.

Produce Code	VFRA4F-XXXXP	VFRB4F-XXXXP	VFRC4F-XXXXP
<b>Power Consumption(W)</b>	60W	40W	40W
<b>Lumens Delivered (lm)</b>	7800lm	5200lm	4200lm
<b>Efficacy (lm/W)</b>	130lm/W(Frosted) 150lm/W(Clear)	130lm/W(Frosted) 150lm/W(Clear)	105lm/W(Frosted) 130lm/W(Clear)
<b>Beam Angle</b>	120°	120°	120°
<b>CRI</b>	80	80	80
<b>Power Factor</b>	>0.9	>0.9	>0.9
<b>Housing</b>	PC	PC	PC
<b>Installation</b>	Surface Mount/ Chain	Surface Mount/ Chain	Surface Mount/ Chain
<b>Operating Temperature</b>	-40°C up to 50°C (-40°F up to 122°F)	-40°C up to 50°C (-40°F up to 122°F)	-40°C up to 50°C (-40°F up to 122°F)
<b>Certification</b>	UL/cUL, DLC Premium	UL/cUL, DLC Premium	UL/cUL, DLC

### LUMINAIRE PHOTOMETRIC

Cone illuminance Diagram:

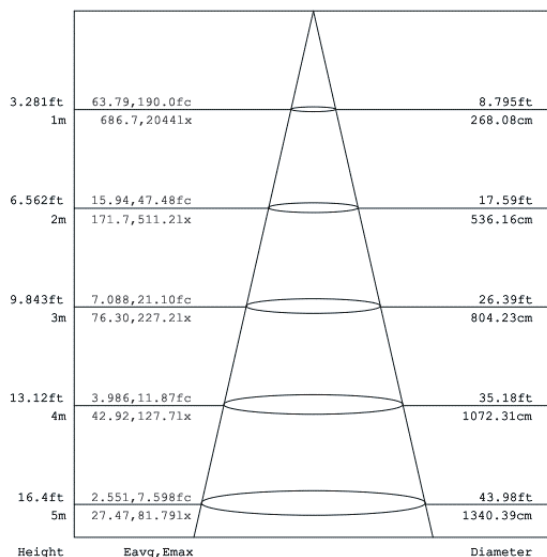

Luminous Intensity Distribution Diagram:

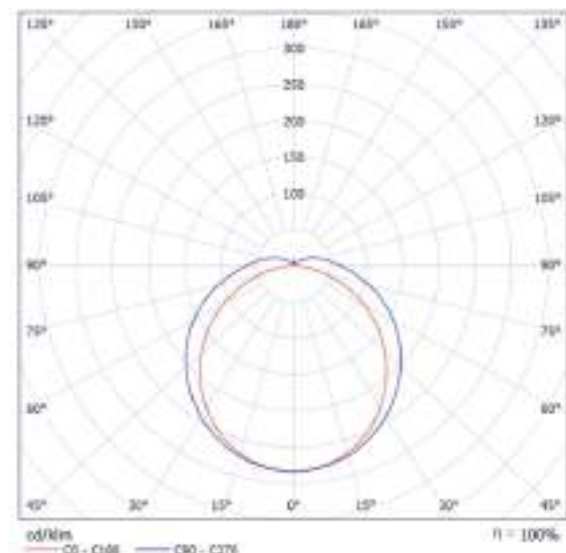



# VFR Series

## The IP65 non-corrosive that outperforms its competitors



GOOD THERMAL MANAGEMENT. Top of the range UL approved flicker-free driver installed on separate heat sink gear tray for good thermal management and long-life.



ALL-POLYCARBONATE CONSTRUCTION. V0 fire retardant polycarbonate ensure high standard of safety and maximum impact rate of IK08.

REVOLUTIONARY DESIGN. Advanced design of polycarbonate diffuse integrated with lighting tray provide significant protection on LEDs and saving on installation and maintenance.



MICRO-WAVE & EMERGENCY AVAILABLE. Suitable for various kinds of applications.

**WARNING :**

- The light source contained in this luminaire shall only be replaced by the manufacturer or his service agent or a similar qualified person.
- If the external flexible cable or cord of this luminaire is damaged, it shall be exclusively replaced by the manufacturer or his service agent or a similar qualified person in order to avoid a hazard.
- Maximum number/power of fittings for loop in/out power option: 10 units/ 750W

# VFR Series

## Motion sensor is optional (BRI810-H-D)

### Utilizing Field And Introduction

BRI810-H-D is a moving object sensor that can detect range of 360° and its working frequency is 5.8GHz. The advantage of this product is stable working state (stable working temperature : -40°C-+70°C), BRI810-H-D adopts a microwave sensor (high-frequency output<0.2mW), so that it is safe and performs better than infrared sensor.



BRI810-H-D

RC-100 (OPTIONAL)

### Function And Options

The microwave sensor to achieve tri-level dimming control, for same areas that require a light change notice before switch off.

It offers 3 levels of the light Control : 100%--dimming light (0,10%,30%,50%) --off; and 2 periods of selectable waiting time: motion hold-time and stand-by time. Selectable daylight threshold and choice of detection area.

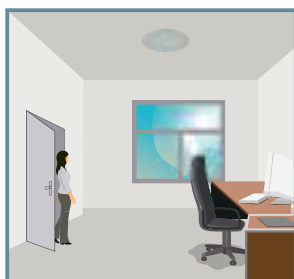

With sufficient natural light, the light does not switch on when presence detected.

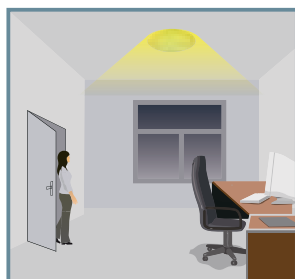

With insufficient natural light, the sensor switches on the light automatically when person enters room.

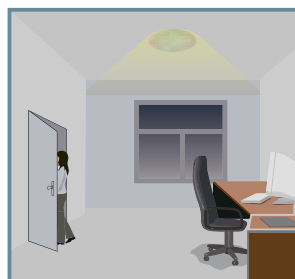

People left, light still dims to 0/10%/30%/50%(options) standby level after the hold time.

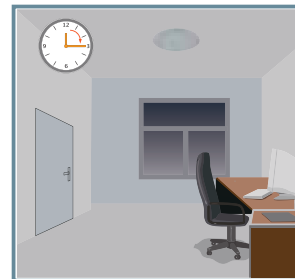

Light switches off automatically after after stand-by time elapsed.

## Emergency

VFRA Emergency LED Driver - R/C, FTBR2/8, rated 100-277V, 50/60Hz, 65mA, 4W input. 15-55Vdc, 850 mA, 13.5W output. Charge Time, 24 Hours. Run Time, 90 minutes.

VFRB Emergency LED Driver - R/C, FTBR2/8, rated 100-277V, 50/60Hz, 50mA, 2.5W input. 15-55Vdc, 470 mA, 7W output. Charge Time, 24 Hours. Run Time, 90 minutes.

VFRC,VFRE non-Emergency option



## PACKAGING

Model No.	Qty (pcs)	L*W*H (CM)	QTY Per Carton	Carton QTY	NW. (kgs)		G.W. (kgs)		Meas. (CBM)	
					Per CTN	TOTAL	Per CTN	TOTAL	Per CTN	TOTAL
VFRA/VFRB	6	123*28.5*31	6	1	15.2	15.2	16.5	16.5	0.11	0.11
VFRC	9	123*31*30	9	1	15.5	15.5	16.8	16.8	0.11	0.11